

KENNZEICHENLEUCHE

Um das Nummernschild bestmöglich ersichtlich zu machen, bietet das Sortiment von Aspöck Kennzeichenleuchten mit unterschiedlichen Designs an.

Durch die verschiedenen Anschlüsse kann die Leuchte einfach und schnell mit dem vorhandenen Kabelsystem verbunden werden.

NUMBER PLATE LAMP

In order to make the number plate as visible as possible, the Aspöck range offers registration plates in different designs.

Due to the different connections, the lamp can be easily and quickly connected with the existing cable system.

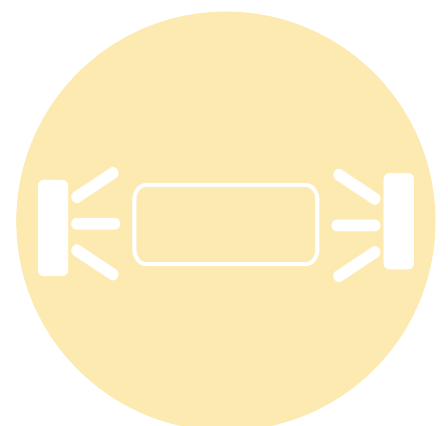



REGPOINT II LED









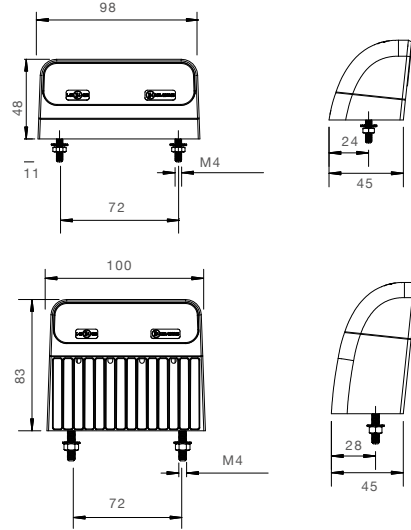













































ADR
Zone 2

IP 54



 Kennzeichenlicht
Number plate light



BEST. NR					ZUSATZ	ANSCHLUSS
PART NO					ADD ON	CONNECTOR
36-3804-004	1/-	LED	12V 24V			P&R  0,50 m 
36-3804-014	1/-	LED	12V 24V			P&R  2,00 m 
36-3806-004	1/-	LED	12V 24V			2 pol. ASS2    0,50 m 
36-3805-004	1/-	LED	12V 24V			2 pol. ASS2    2,00 m 
36-3807-004	1/-	LED	12V 24V			2 pol. Superseal    0,50 m 
36-3810-004	1/-	LED	12V 24V			3 pol. ASS3    0,50 m 
36-3864-004	1/-	LED	12V 24V		für Einzelanbau for single mounting	P&R  0,50 m 
36-3864-014	1/-	LED	12V 24V		für Einzelanbau for single mounting	P&R  2,00 m 
36-3867-014	1/-	LED	12V 24V		für Einzelanbau for single mounting	2 pol. ASS2    0,50 m 
36-3867-024	1/-	LED	12V 24V		für Einzelanbau for single mounting	2 pol. ASS2    2,00 m 
36-3865-004	1/-	LED	12V 24V		für Einzelanbau for single mounting	3 pol. ASS3    0,50 m 
36-3867-004	1/-	LED	12V 24V		für Einzelanbau for single mounting	2 pol. Superseal    0,50 m 

A.PIERINGER GmbH

www.ap.works

2141 Ameis, Obere Hauptstraße 68

Telefon: +43 / 2425 / 278 00

E-Mail: vk@ap.co.at



REGPOINT II LED

ZUBEHÖR / ACCESSORIES

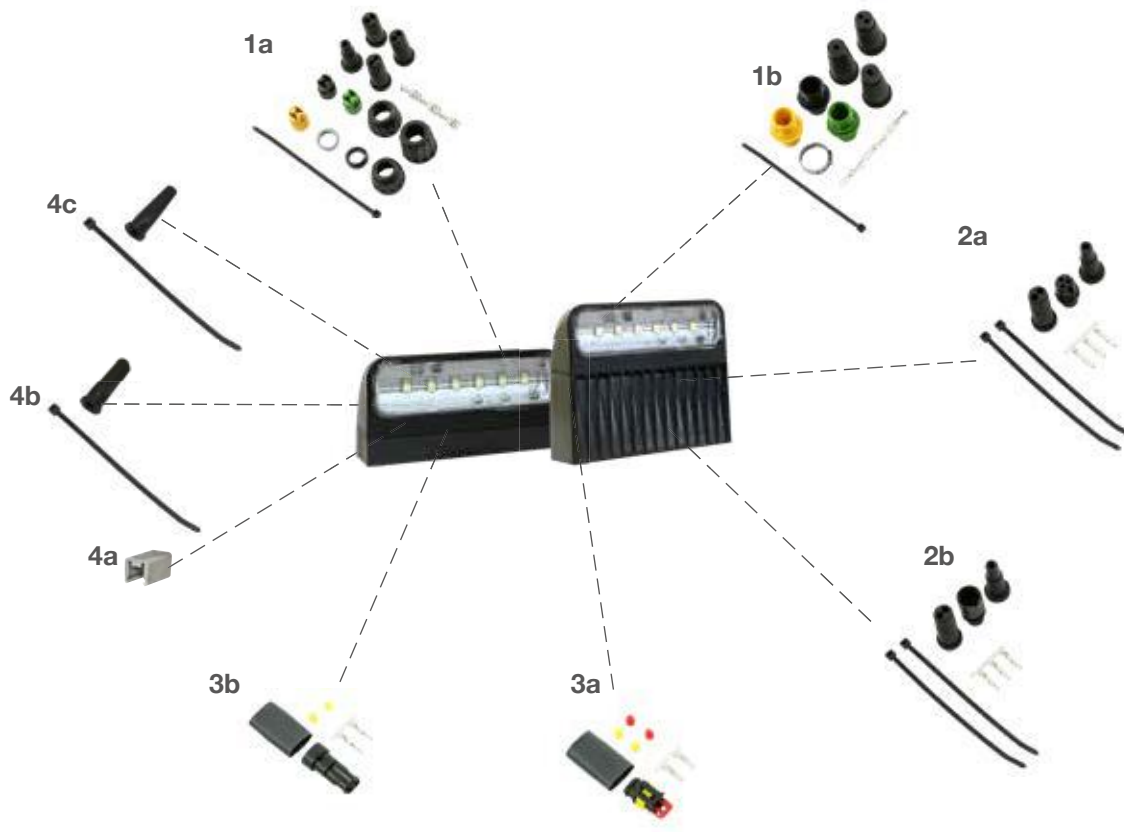

- 1 ASS1 & ASS2 Verbinder | ASS1 & ASS2 connector**
- (a) 2 pol. weiblich
2 pin female 13-5626-401
 - (b) 2 pol. männlich
2 pin male 13-5625-991
- 2 ASS3 Verbinder | ASS3 connector**
- (a) 3 pol. weiblich
3 pin female 13-0322-281
 - (b) 3 pol. männlich
3 pin male 13-0332-281
- 3 Superseal Verbinder | Superseal connector**
- (a) 2 pol. weiblich
2 pin female 15-7002-044
 - (b) 2 pol. männlich
2 pin male 15-7002-054

- 4 für P&R Verbinder | for P&R connector**
- (a) Verschlusskappen
caps 15-5971-014
 - (b) Endkappen rund
end caps round 15-5983-024
 - (c) Endkappen eckig
end caps square 15-5729-014









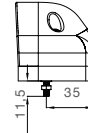
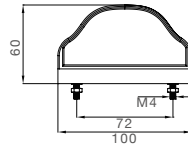
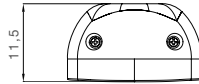



















































REGPOINT LED

ADR
Zone 2

IP 54



Kennzeichenlicht
Number plate light

BEST. NR				ZUSATZ	ANSCHLUSS
PART NO				ADD ON	CONNECTOR
36-3607-004	1/-	LED	24V		2 pol. ASS2 2 pin ASS2 ♀    0,50 m 
36-3607-034	1/-	LED	24V		2 pol. ASS2 2 pin ASS2 ♀    0,80 m 
36-3607-014	1/-	LED	24V		2 pol. ASS2 2 pin ASS2 ♀    1,00 m 
36-3607-024	1/-	LED	24V		2 pol. ASS2 2 pin ASS2 ♀    3,50 m 
36-3607-074	1/-	LED	24V		3 pol. ASS3 3 pin ASS3 ♀    0,50 m 
36-3607-094	1/-	LED	24V		3 pol. ASS3 3 pin ASS3 ♀    1,00 m 
36-3690-004	1/-	LED	24V		2 pol. AFK plus lear 2 pin AFK plus lear   0,50 m 
36-3690-034	1/-	LED	24V		2 pol. Deutsch 2 pin Deutsch ♂    0,17 m 
36-3600-044	1/-	LED	24V		2 pol. Superseal 2 pin Superseal ♀    0,25 m 
36-3690-014	1/-	LED	24V		2 pol. Superseal 2 pin Superseal ♂    3,50 m 
36-3690-024	1/-	LED	24V		2 pol. Superseal 2 pin Superseal ♀    1,20 m 
36-3690-044	1/-	LED	24V		2 pol. Superseal 2 pin Superseal ♂    0,15 m 
36-3600-004	1/-	LED	24V		offenes Ende open end 0,50 m 
36-3600-014	1/-	LED	24V		offenes Ende open end 1,00 m 
36-3600-024	1/-	LED	24V		offenes Ende open end 3,50 m 
36-3604-004	1/-	LED	24V		P&R   0,50 m 
36-3604-014	1/-	LED	24V		P&R   1,00 m 
36-3604-024	1/-	LED	24V		P&R   1,50 m 



REGPOINT LED

ZUBEHÖR / ACCESSORIES

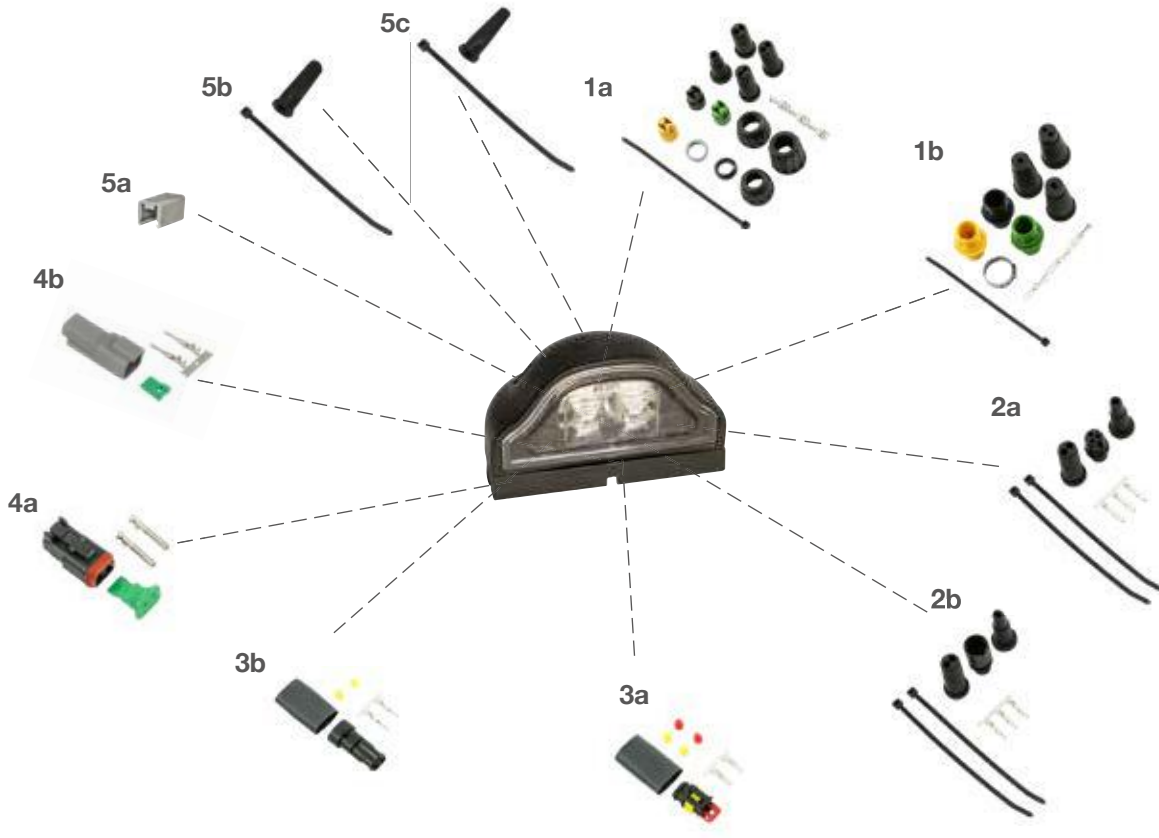

- 1 ASS1 & ASS2 Verbinder | ASS1 & ASS2 connector**
- (a) 2 pol. weiblich
2 pin female 13-5626-401
 - (b) 2 pol. männlich
2 pin male 13-5625-991
- 2 ASS3 Verbinder | ASS3 connector**
- (a) 3 pol. weiblich
3 pin female 13-0322-281
 - (b) 3 pol. männlich
3 pin male 13-0332-281
- 3 Superseal Verbinder | Superseal connector**
- (a) 2 pol. weiblich
2 pin female 15-7002-044
 - (b) 2 pol. männlich
2 pin male 15-7002-054

- 4 Deutsch Verbinder | Deutsch connector**
- (a) 2 pol. weiblich
2 pin female 15-7002-135
 - (b) 2 pol. männlich
2 pin male 15-7002-125
- 5 für P&R Verbinder | for P&R connector**
- (a) Verschlusskappen
caps 15-5971-014
 - (b) Endkappen rund
end caps round 15-5983-024
 - (c) Endkappen eckig
end caps square 15-5729-014









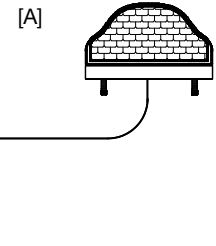
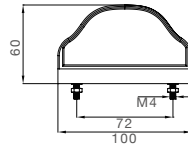
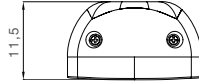









































REGPOINT

ADR
Zone 2

IP 54



 Kennzeichenlicht
Number plate light

BEST. NR				ZUSATZ	ANSCHLUSS	
PART NO				ADD ON	CONNECTOR	
36-3002-014	1/-		24V		offenes Ende open end	1,00 m 
36-3003-014	1/-		24V		offenes Ende open end	0,30 m 
36-3004-014	1/-		24V	M4x16	P&R 	0,50 m 
36-3004-024	1/-		24V		P&R 	1,00 m 
36-3004-034	1/-		24V		P&R 	1,50 m 
36-3004-044	1/-		24V		P&R 	2,00 m 
36-3004-054	1/-		24V		P&R 	3,50 m 
36-3007-284	1/-		24V		2 pol. ASS2 2 pin ASS2 	0,55 m 
36-3007-254	1/-		24V		2 pol. ASS2 2 pin ASS2 	1,20 m 
36-3007-084	1/-		24V		2 pol. ASS2 2 pin ASS2 	3,50 m 
36-3007-394	1/-		24V	M4x16	3 pol. ASS3 3 pin ASS3 	0,50 m 
36-3007-464	1/-		24V	M4x35	3 pol. ASS3 3 pin ASS3 	0,50 m 
36-3007-264	1/-		24V	[A]	2 pol. ASS2 2 pin ASS2  2 pol. ASS2 2 pin ASS2 	1,02 m  0,2 m 
36-3000-134	1/-		24V		2 pol. Superseal 2 pin Superseal 	1,20 m 
36-3007-574	1/-		24V		2 pol. ASS2 2 pin ASS2 	0,70 m 



REGPOINT

ZUBEHÖR / ACCESSORIES

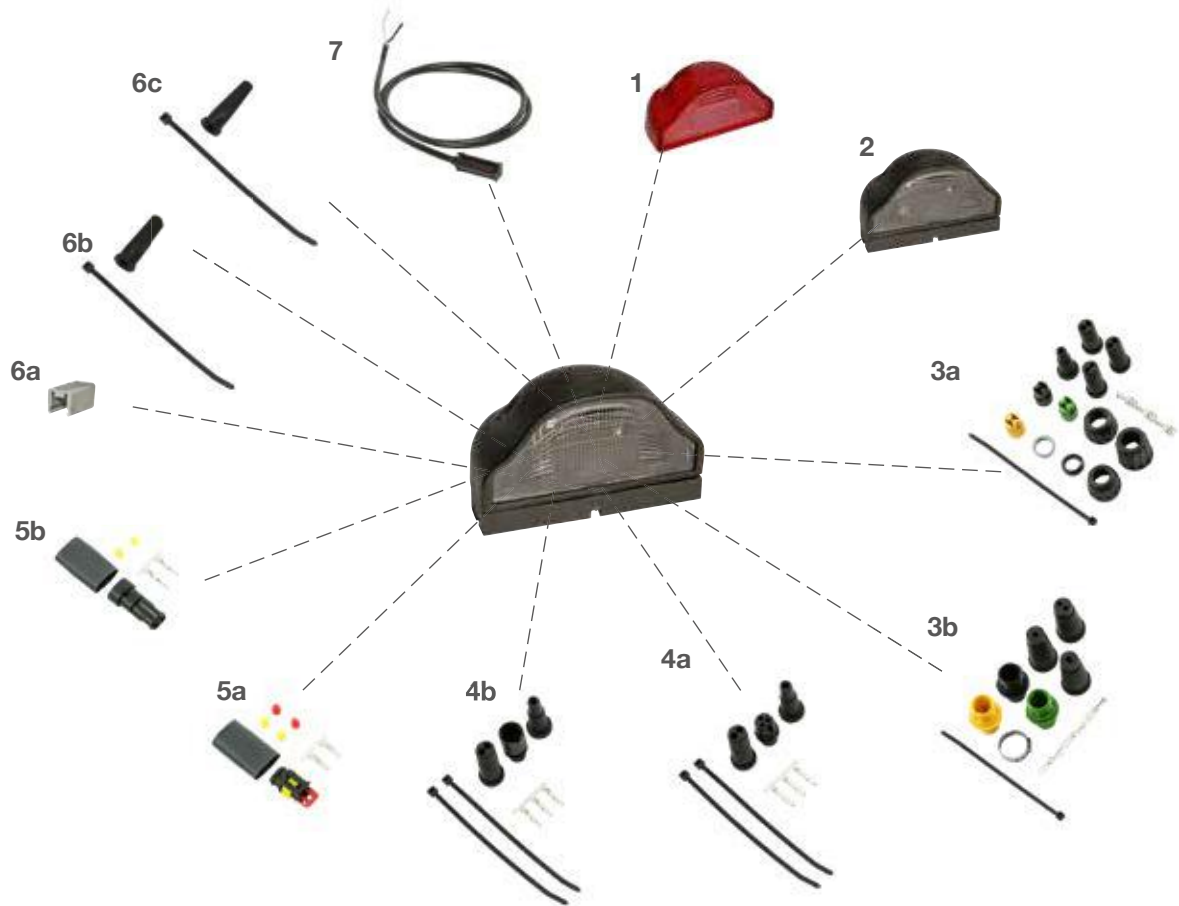

1 Lichtscheibe | lens
transparent rot
transparent red 18-8630-104

2 Ersatzteilleuchte |
spare part lamp
weiß mit Schrauben
white with screws 26-3000-004

3 ASS1 & ASS2 Verbinder |
ASS1 & ASS2 connector
(a) 2 pol. weiblich
2 pin female 13-5626-401
(b) 2 pol. männlich
2 pin male 13-5625-991

4 ASS3 Verbinder | ASS3 connector
(a) 3 pol. weiblich
3 pin female 13-0322-281
(b) 3 pol. männlich
3 pin male 13-0332-281

5 Superseal Verbinder | Superseal connector
(a) 2 pol. weiblich
2 pin female 15-7002-044
(b) 2 pol. männlich
2 pin male 15-7002-054

6 für P&R Verbinder |
for P&R connector
(a) Verschlusskappen
caps 15-5971-014
(b) Endkappen rund
end caps round 15-5983-024
(c) Endkappen eckig
end caps square 15-5729-014

7 Zuleitung P&R | front connection P&R
0,5 m 68-5000-574
1,5 m 68-5000-604
2,0 m 68-5000-624
5,0 m 68-5000-634





REGPOINT rot
red

ADR
Zone 2

IP 54

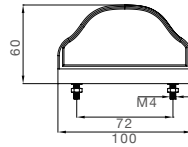
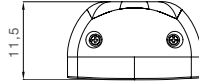

Kennzeichenlicht
Number plate light

BEST. NR				ZUSATZ	ANSCHLUSS		
PART NO				ADD ON	CONNECTOR		
36-3004-184	1/-		24V		P&R		0,50 m
36-3004-084	1/-		24V		P&R		1,50 m



REGPOINT rot
red

ZUBEHÖR / ACCESSORIES

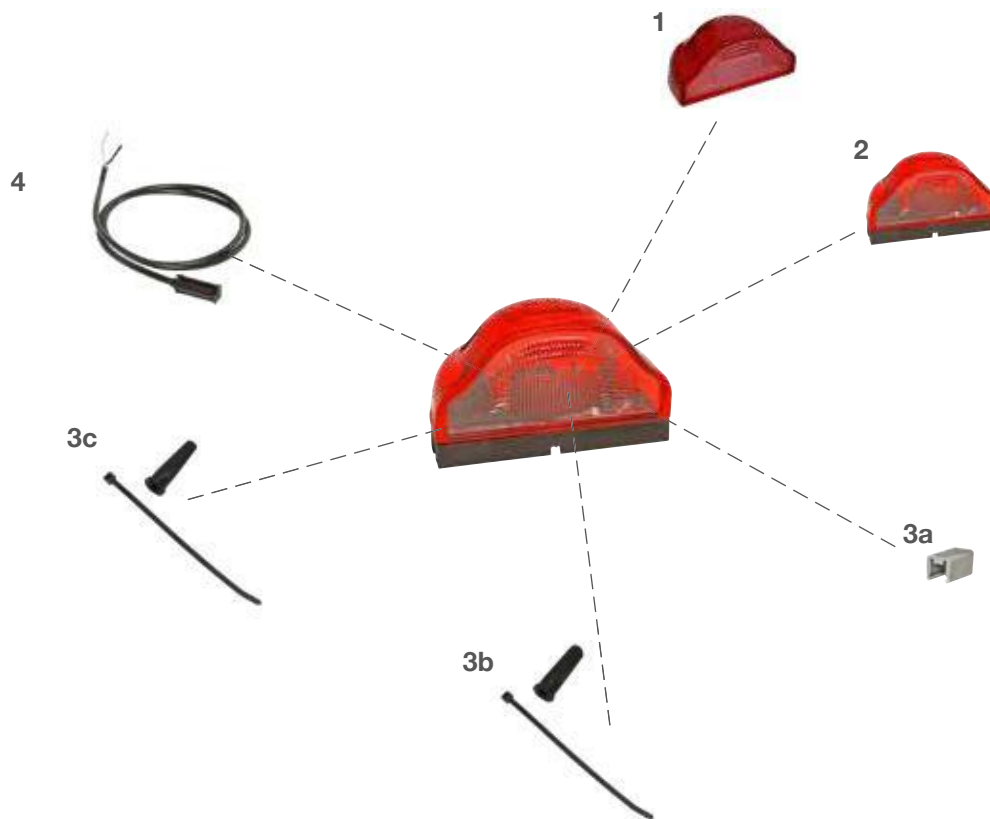

1 Lichtscheibe | lens
transparent rot
transparent red 18-8630-104

2 Ersatzteileuchte |
spare part lamp
rot mit Schrauben
red with screws..... 26-3010-004

3 für P&R Verbinder |
for P&R connector
(a) Verschlusskappen
caps..... 15-5971-014
(b) Endkappen rund
end caps round..... 15-5983-024
(c) Endkappen eckig
end caps square 15-5729-014

4 Zuleitung P&R | front connection P&R
0,5 m..... 68-5000-574
1,5 m..... 68-5000-604
2,0 m..... 68-5000-624
5,0 m..... 68-5000-634







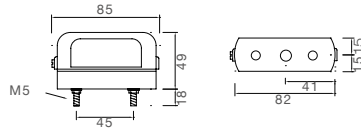











REGPOINT klein
small



 Kennzeichenlicht
Number plate light

BEST. NR				ZUSATZ ADD ON	ANSCHLUSS CONNECTOR
PART NO					
26-1200-004	1/-	-			Tülleneingang grommet  
36-1204-034	1/-		24V		P&R   0,50 m 
36-1207-004	1/-		24V		2 pol. ASS2 2 pin ASS2    1,50 m 



REGPOINT klein
small

ZUBEHÖR / ACCESSORIES

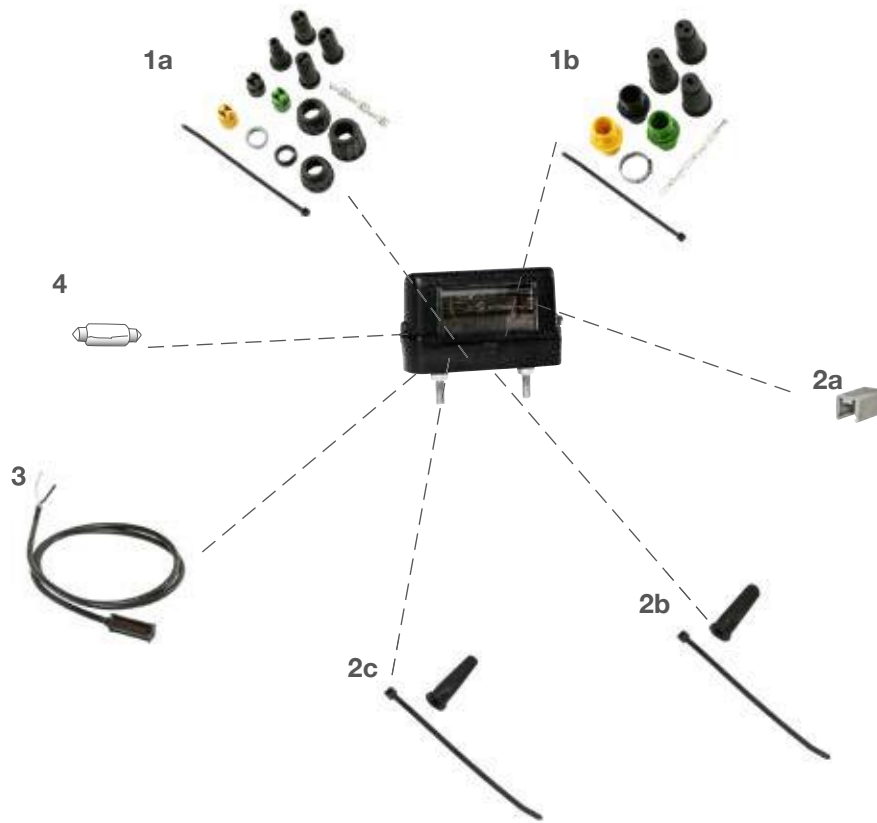

1 ASS1 & ASS2 Verbinder |
ASS1 & ASS2 connector

- (a) 2 pol. weiblich
2 pin female 13-5626-401
- (b) 2 pol. männlich
2 pin male 13-5625-991

2 für P&R Verbinder |
for P&R connector

- (a) Verschlusskappen
caps 15-5971-014
- (b) Endkappen rund
end caps round 15-5983-024
- (c) Endkappen eckig
end caps square 15-5729-014

3 Zuleitung P&R | front connection P&R
0,5 m 68-5000-574

4 Soffitte
24V 5W 16-6705-017

PIKTOGRAMM ÜBERSICHT / PICTOGRAM OVERVIEW

PIKTOGRAMM ÜBERSICHT			
	Verpackungseinheit		Begrenzungslicht vorne
	x Stück pro Karton		rot, weiß, orange
	links		rot, weiß
	rechts		rot
	Leuchtmittel		weiß
	Volt		Umrissleuchte
	Umrissarm		Rückstrahler rot
	Glühbirne		Rückstrahler gelb
	LED		Rückstrahler weiß
	Blinklicht		Arbeitsscheinwerfer
	Blinklicht rechts		Kennzeichenlicht
	Blinklicht links		Rückfahralarm
	dynamischer Blinker rechts		männlich
	dynamischer Blinker links		weiblich
	mit integriertem Blink- LCG		Flood
	mit integriertem LCG2		Spot
	Rücklicht		horizontal Anbau
	Bremslicht		vertikal Anbau
	Nebelschlusslicht		360° Anbau möglich
	Rückfahrlicht		... Lumen
	Dreieckrückstrahler		... Watt
	ohne Dreieckrückstrahler		ADR Zone 2
	Positionslicht		IP xx Schutzklasse
	Seitenmarkierungslicht		
	ohne Seitenmarkierungs- licht		
	Seitenmarkierungslicht + Reflektor		
	Begrenzungslicht hinten		

PICTOGRAM OVERVIEW			
	Packaging unit		Front position light
	x pieces per box		red, white, amber
	Left		red, white
	Right		red
	Light source		white
	Volt		End outline marker
	End Outline marker		Reflector red
	Bulb		Reflector amber
	LED		Reflector white
	Direction indicator		Working lamp
	Direction indicator right		Number plate light
	Direction indicator left		Reverse alarm
	Progressive direction indicator right		Male
	Progressive direction indicator left		Female
	With integrated direction indicator LCG		Flood
	With integrated LCG2		Spot
	Tail light		Horizontal mounting
	Stop light		Vertical mounting
	Fog light		360° mounting possible
	Reverse light		... Lumen
	Triangle reflector		... Watt
	Without triangle reflector		ADR Zone2
	Position light		IP xx Rating
	Sidemarker light		
	Without sidemarker light		
	Sidemarker light + reflector		
	Rear position light		

PIKTOGRAMM ÜBERSICHT / PICTOGRAM OVERVIEW

LEGENDA			
	Pezzi per confezione		Luce di posizione anteriore
	Pezzi per scatola		Rosso, bianco, arancione
	Sinistro		Rosso, bianco
	Destro		Rosso
	Tipo di luce		Bianco
	Volt		Luce d'ingombro
	Luce d'ingombro		Catadiottro rosso
	Lampadina		Catadiottro arancione
	LED		Catadiottro bianco
	Freccia		Faro da lavoro
	Freccia destra		Luce targa
	Freccia sinistra		Segnalatore acustico per retromarcia
	Freccia progressiva destra		Maschio
	Freccia progressiva sinistra		Femmina
	Con LCG per freccia		Flood
	Con LCG per tutte le funzioni		Spot
	Luce di posizione		Montaggio orizzontale
	Stop		Montaggio verticale
	Retronebbia		Montaggio a 360°
	Retromarcia		Lumen
	Catadiottro triangolare		Watt
	Senza catadiottro triangolare		ADR Zone 2
	Luce di posizione destra		IPXX
	Luce laterale		
	Senza luce laterale		
	Luce laterale + catadiottro		
	Luce di posizione posteriore		

LÉGENDE DES PICTOGRAMMES			
	Conditionnement		Feu de gabarit avant
	X pièces par carton		Rouge, blanc, orange
	Gauche		Rouge, blanc
	Droit		Rouge
	Source lumineuse		Blanc
	Voltage		Feu d'encombrement
	Feu sur antenne		Catadioptr rouge
	Ampoule		Catadioptr orange
	LED		Catadioptr blanc
	Clignotant		Phare de travail
	Clignotant droit		Eclaireur de plaque
	Clignotant gauche		Alarme de recul
	Clignotant à défilement droit		Mâle
	Clignotant à défilement gauche		Femelle
	Avec LCG clignotant intégré		Large
	Avec LCG toutes fonctions intégré		Etroit
	Feu de position		Montage horizontal
	Feu de stop		Montage vertical
	Feu de brouillard		Montage à 360° possible
	Feu de recul		... Lumen
	Catadioptr triangulaire		... Watt
	Sans catadioptr triangulaire		ADR Zone 2
	Feu de gabarit		Classe IPxx
	Feu latéral orange		
	Sans feu latéral orange		
	Feu latéral orange+catadioptr		
	Feu de gabarit arrière		

PIKTOGRAMM ÜBERSICHT / PICTOGRAM OVERVIEW

DESCRIPCIÓN DE PICTOGRAMA	
	Unidad de embalaje
	x piezas por caja
	Izquierdo
	derecho
	Tipo de luz
	Voltaje
	Cuerno final de linea
	Lámpara
	LED
	Indicador de dirección
	Indicador de dirección-derecho
	Indicador de dirección izquierdo
	Indicador de dirección progresivo derecho
	Indicador de dirección progresivo izquierdo
	Con indicador de dirección integrado en LCG
	Con LCG integrado (todas las funciones)
	Luz de gálibo
	Luz de Freno
	Luz Antiniebla
	Luz Marcha atrás
	Triángulo reflectante
	Sin Triángulo reflectante
	Luz de posición
	Luz lateral
	Sin Luz lateral
	Luz lateral + reflectante
	Gálibo trasero
	Gálibo delantero
	rojo, blanco, ambar
	rojo, blanco
	rojo
	blanco
	Cuerno final de linea
	Reflectante rojo
	Reflectante ambar
	Reflectante blanco
	Faro de trabajo
	Luz de matrícula
	Retro-alarma
	Macho
	Hembra
	Amplia
	Larga
	Montaje Horizontal
	Montaje Vertical
	Montaje 360°
	Lumen
	Wattios
	Zona 2 ADR
	Tipo IPxx

LEGENDA	
	Jednostka miary
	x sztuk w kartonie
	Lewa
	Prawa
	ródło światła
	Napięcie
	Obrys gumowy narożny
	arówka
	LED
	Kierunkowskaz
	Prawy kierunkowskaz
	Lewy kierunkowskaz
	Prawy kierunkowskaz progresywny
	Lewy kierunkowskaz progresywny
	Ze zintegrowanym LCD dla kierunkowskazu
	Ze zintegrowanym LCD dla wszystkich funkcji
	wiatro pozycyjne tylne
	Stop
	wiatro przeciwmglowe
	Wsteczny
	Trójkąt z odblaskiem
	Trójkąt bez odblasku
	wiatro pozycyjne
	wiatro obrysowe boczne
	Bez wiatro obrysowego boczego
	wiatro obrysowe boczne + odblask
	wiatro pozycyjne tylne
	wiatro pozycyjne przednie
	Czerwone, Białe, Pomarańczowe
	Czerwone, Białe
	Czerwone
	Białe
	Obrys gumowy narożny
	Odblask czerwony
	Odblask pomarańczowy
	Odblask biały
	Lampa robocza
	Oświetlenie tablicy rejestracyjnej
	Dźwiękowy sygnalizator cofania
	Męska
	żeńskie
	wiatro rozproszone
	wiatro skupione
	Montaż poziomy
	Montaż pionowy
	Montaż 360°
	Lumen
	Watt
	Sterfa 2 ADR
	Klasa IPXX

PIKTOGRAMM ÜBERSICHT / PICTOGRAM OVERVIEW

PIKTOGRAM ÖZETİ			
	Paketleme Sayısı		Pozisyon Lamba - Beyaz
	Her kutuda x adet		Kırmızı, Beyaz, Sarı
	Sol		Kırmızı, Beyaz
	Sağ		Kırmızı
	Lamba		Beyaz
	Voltaj		Boynuz Lamba
	Boynuz Lamba		Kırmızı Reflektör
	Ampul		Sarı Reflektör
	LED		Beyaz Reflektör
	Sinyal Lamba		Çalışma Lambası
	Sinyal Lamba Sağ		Plaka Lambası
	Sinyal Lamba Sol		Geri Vites İkaz Sireni
	Progresif Sinyal Lamba Sağ		Erkek
	Progresif Sinyal Lamba Sol		Dişi
	LCG'li sinyal lamba		Geniş Açı
	LCG'li (Bütün Fonksiyonlar)		Spot
	Park Lamba		Yatay Montaj
	Fren Lamba		Dikey Montaj
	Sis Lamba		360° Uygulanabilir
	Geri Vites Lamba		... Lumen
	Üçgen Reflektör		... Watt
	Üçgen Reflektörsüz		ADR Zone 2
	Pozisyon Lamba		IP Sınıfı
	Yan Park Lamba		
	Yan Park Lambasız		
	Yan Park Lamba+Reflektör		
	Gabari Lamba - Kırmızı		

KUVIEN SELITYS			
	Pakkauskoko		Etuäärivalo
	X per laatikko		Punainen, valkoinen, keltainen
	Vasen		Punainen, valkoinen, keltainen
	Oikea		Punainen
	Valolähde		Valkoinen
	Voltia		Kumivarsivalo
	Kumivarsivalo		Heijastin punainen
	Polttimo		Heijastin keltainen
	LED		Heijastin valkoinen
	Vilkku		Työvalo
	Vilkku oikea		Rekisterikilven valo
	Vilkku vasen		Peruutushälytін
	Progressiivinen vilkku oikea		Uros
	Progressiivinen vilkku vasen		Naaras
	LCG:llä vilkkua varten		Leveä valokuvio (flood)
	LCG:llä kaikkia toimintoja varten		Kapea valokuvio (spot)
	Parkkivalo		Vaaka-asennus
	Jarruvalo		Pystyasennus
	Sumuvalo		360° asennus mahdollinen
	Peruutusvalo		... Lumenia
	Heijastinkolmio		... Wattia
	Ilman heijastavaa kolmiota		ADR Zone 2
	Äärivalo		IP xx luokitus
	Sivuäärivalo		
	Ilman sivuäärivaloa		
	Sivuäärivalo + heijastin		
	Takaäärivalo		

PIKTOGRAMM ÜBERSICHT / PICTOGRAM OVERVIEW

ÖVERSIKT	
	Förpacknings-storlek
	x per kartong
	Vänster
	Höger
	Ljuskälla
	Volt
	Breddmarkering
	Glödlampa
	LED
	Blinkers
	Blinkers Höger
	Blinkers Vänster
	Progressiv blinkers höger
	Progressiv blinkers vänster
	Med integrerad LCG för blinkers
	Med integrerad LCG för alla funktioner
	Parkeringsljus
	Bromsljus
	Dimljus
	Backljus
	Reflextriangel
	Utan reflextriangel
	Positionsljus
	Sidomarkeringsljus
	Utan Sidomarkeringsljus
	Sidomarkering + reflex
	Bakre positionsljus
	Främre positionsljus
	Röd, vit, gul
	Röd, vit
	Röd
	Vit
	Breddmarkering
	Reflex röd
	Reflex gul
	Reflex vit
	Arbetsbelysning
	Nummerplåtsbelysning
	Backvarnare
	Hane
	Hona
	Bred ljusbild (flood)
	Smal ljusbild (spot)
	Horisontell montering
	Vertikal montering
	360° montering möjlig
	...Lumen
	...Watt
	ADR Zone 2
	IP xx Klass

PICTOGRAM OVERZICHT	
	Verpakkingseenheid
	x stuks per doos
	links
	rechts
	lichtbron
	volt
	Pendelarm
	bollamp
	LED
	Knipperlicht
	Knipperlicht rechts
	Knipperlicht links
	dynamisch knipperlicht rechts
	dynamisch knipperlicht links
	met geïntegreerde knip- perlicht LCG
	met geïntegreerde LCG (alle functies)
	Achterlicht
	Remlicht
	Mistlicht
	Achteruitrijlicht
	Driehoek reflector
	zonder driehoek re- flector
	Positielicht
	Zijmarkeringslicht
	zonder zijmarkeringslicht
	Zijmarkeringslicht + reflector
	Positielicht achter
	Positielicht voor
	rood, wit, oranje
	rood, wit
	rood
	wit
	markeringslicht
	Reflector rood
	Reflector geel
	Reflector wit
	Werklamp
	Kentekenlamp
	Achteruitrij alarm
	mannelijk
	vrouwelijk
	Flood
	Spot
	horizontale montage
	verticale montage
	360° montage mogelijk
	Lumen
	Watt
	ADR Zone 2
	IPxx Klasse

Aspöck Systems GmbH

Enzing 4 | 4722 Peuerbach | AUSTRIA
Phone.: +43 72 76 / 26 70-0 | Fax: DW 1199
E-Mail: office@aspoeck.com | www.aspoeck.com



Management System
ISO 9001:2008
VDA 6.1
www.tuv.com
ID: 9105017409

www.aspoeck.com

UNITED KINGDOM, EIRE

Aspöck UK Ltd.
Unit 19, Stansted Distribution Centre
Great Hallingbury
Bishops Stortford, Herts
GB-CM22 7DG
Tel.: +44 1279 655 220
Fax: +44 1279 505 869
E-Mail: sales@aspoeck.co.uk
www.aspoeck.co.uk

**FRANCE, ALGERIA,
MOROCCO, TUNISIA**

Aspöck France S.A.S.
ZAC Bel Air
260 Rue des Vergers
F-69480 Pommiers
Tel.: +33 437 5508 65
Fax: +33 437 5508 97
E-Mail: office@aspoeck.fr
www.aspoeck.com

SPAIN, PORTUGAL

Aspöck Iberica
Via Sergia, 32 Nave N° 2
Poligono Industrial
"Les Hortes del Cami Ral"
E-08302 Mataro (Barcelona)
Tel.: +34 937 598 039
Fax: +34 937 501 033
E-Mail: aspock@aspock.com
www.aspock.com

**SWEDEN, FINLAND, NORWAY,
DENMARK, ESTONIA**

Aspöck Norden AB
Birger Svenssons väg 16E
SE-432 40 Varberg
Tel.: +46 340 483 870
Fax: +46 340 483 879
E-Mail: order@aspoeck-norden.se
www.aspoeck.com

ITALY

PAGG Aspöck srl
Via Legnano, 8
I-20835 Muggiò (MB)
Tel.: +39 039 278 5255
Fax: +39 039 278 9582
E-Mail: info@aspoeck.it

BRAZIL

Aspock do Brasil Ltda.
Estrada RS 122 km 88,5 S/N
Bairro São Gotardo
Flores da Cunha-RS
CEP 95270-000
Tel.: +55 54 3039-5400
E-Mail: contato@aspock.com.br
www.aspock.com

**POLAND, LITHUANIA, LATVIA,
UKRAINE**

Aspöck Systems Polska Sp.z.o.o.
ul. Byczyńska 10
46-320 Praszka
Tel.: +48 34 3430 600
Fax.: +48 34 3430 609
E-Mail: office.poland@aspoeck.com
www.aspoeck.com

TURKEY, MIDDLE EAST

Aspöck Aydınlatma Sist. Tic. Ltd. Şti.
Feneryolu Mah. Yıldırım Sok.
No 20/B 34724
Kadıköy / Istanbul
Turkey
Tel.: +90 216 510 54 00
E-Mail: infoturkey@aspoeck.com
www.aspock.com

GERMANY

Suer GmbH & Co KG
Handelsstraße 5
D-42929 Wermelskirchen
Tel.: +49 2196 946 0
Fax: +49 2196 946 100
E-Mail: info@suer.de

GERMANY

Hofmeister & Meincke
Carsten-Dressler-Straße 6
D-28279 Bremen
Tel.: +49 421 8405 296
Fax: +49 421 8405 201
E-Mail: bremen@hofmei.de

**AUSTRIA, HUNGARY, CROATIA,
CZECH REPUBLIC,**

Ing. A. F. Baeder Ges.m.b.H.
Leopoldgasse 13-17
A-1230 Wien
Tel.: +43 1 865 16 40
Fax: +43 1 869 22 12
E-Mail: sales@baeder-automotive.com

AUSTRIA (ONLY 12V)

Knott Handelsges.m.b.H.
Rennweg 79-81
A-1030 Wien
Tel.: +43 1 714 22 22
Fax: +43 1 714 22 33
E-Mail: info@knott.at

SWITZERLAND

AGL AG für Lastwagenzubehöre
Müslistrasse 43
CH-8957 Spreitenbach
Tel.: +41 41 348 04 80
Fax: +41 41 340 31 79
E-Mail: info@agl.ch

NETHERLAND, BELGIUM,

Frits Dijk International
Collse Heide 64
NL-5674 VN Nuenen
Tel.: +31 40 2831815
Fax: +31 40 2838717
E-Mail: info@fritsdijk.nl

**SERBIA, ROMANIA, BULGARIA,
SLOVAKIA**

Ing. A. F. Baeder Ges.m.b.H.
Leopoldgasse 13-17
A-1230 Wien
Tel.: +43 1 865 16 40
Fax: +43 1 869 22 12
E-Mail: sales@baeder-automotive.com

**MONTENEGRO, SLOVENIA,
BOSNIA AND HERZEGOVINA**

Ing. A. F. Baeder Ges.m.b.H.
Leopoldgasse 13-17
A-1230 Wien
Tel.: +43 1 865 16 40
Fax: +43 1 869 22 12
E-Mail: sales@baeder-automotive.com

ISRAEL

M.N. Systems
4 Beith Harishonim st
P.O.B 12186
Industrial Park Emek Hefer 38777,
Israel
Tel.: +97 24 6220 111
Fax: +97 24 6220 808
E-Mail: info@mnsys.co.il

EAST ASIA

JM Company
30, Heungdo-ro 415 beongil
Doekyang-gu, Goyang-si, Gyeonggi-do
412-020, S. Korea
Tel.: +82 31 902 7670
Fax: +82 31 902 7671

**RUSSIA, KYRGYZSTAN, MONGOLIA,
BELARUS, KAZAKHSTAN**

STAT Ltd
141580, Moscow region,
Solnechnogorsky district,
Dubrovki village, Aeroportovskaya str.,
bldg.2, Sherland BC
Tel.: + 7 (495) 739-03-47
email: info@stat-parts.ru
www.stat-parts.ru