

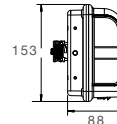

EUROPOINT III links
left

ADR Zone 2 IP 56K

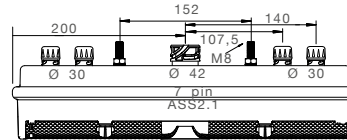
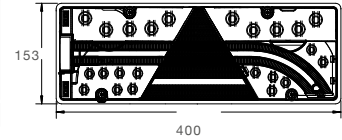
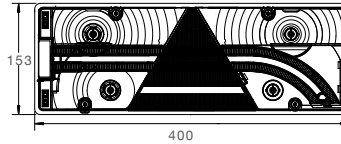

Blinklicht Direction indicator	Rücklicht Tail light	Bremslicht Stop light	Nebelschlusslicht Fog light
Rückfahrlicht Reverse light	Dreieckrückstrahler Triangle reflector	Seitenmarkierungslicht + Reflektor Sidemarker light + reflector	

BEST. NR	PART NO	Box	←	→	LED	24V	Light Type	ZUSATZ ADD ON	ANSCHLUSS CONNECTOR
25-7000-501	1/10	●			LED	24V			7 pol. ASS2.1 7 pin ASS2.1 ♂
25-7000-511	1/10	●			LED	24V			7 pol. ASS2.1 7 pin ASS2.1 ♂ 4 x 2 pol. ASS2 4 x 2 pin ASS2
25-7000-701	1/10	●			LED	24V			7 pol. ASS2.1 7 pin ASS2.1 ♂
25-7000-711	1/10	●			LED	24V			7 pol. ASS2.1 7 pin ASS2.1 ♂ 4 x 2 pol. ASS2 4 x 2 pin ASS2
25-7000-721	1/10	●			LED	24V			7 pol. ASS2.1 7 pin ASS2.1 ♂
25-7000-741	1/10	●			LED	24V			7 pol. ASS2.1 7 pin ASS2.1 ♂
25-7030-721	1/10	●			LED	24V			7 pol. AMP 7 pin AMP ♂ 4 x 2 pol. Superseal 4 x 2 pin Superseal
25-7001-501	1/10	●			LED	24V			7 pol. ASS2.1 7 pin ASS2.1 ♂
25-7001-601	1/10	●			LED	24V			7 pol. ASS2.1 7 pin ASS2.1 ♂ 4 x 2 pol. ASS2 4 x 2 pin ASS2
25-7030-711	1/10	●			LED	24V			7 pol. AMP 7 pin AMP ♂ 4 x 2 pol. Superseal 4 x 2 pin Superseal
25-7001-611	1/10	●			LED	24V			7 pol. ASS2.1 7 pin ASS2.1 ♂ 4 x 2 pol. ASS2 4 x 2 pin ASS2
25-7002-001	1/10	●			LED	24V			7 pol. ASS2.1 7 pin ASS2.1 ♂ 4 x 2 pol. ASS2 4 x 2 pin ASS2
25-7000-761	1/10	●			LED	24V			7 pol. ASS2.1 7 pin ASS2.1 ♂ 4 x 2 pol. ASS2 4 x 2 pin ASS2



EUROPOINT III rechts
right

ADR Zone 2 IP 56K

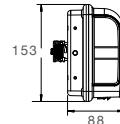
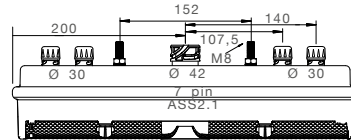
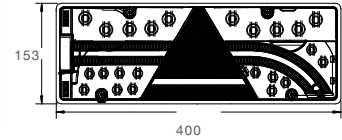
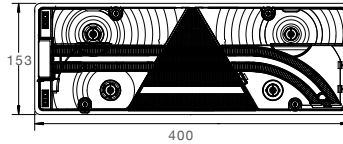

Blinklicht Direction indicator	Rücklicht Tail light	Bremslicht Stop light	Nebelschlusslicht Fog light
Rückfahrlicht Reverse light	Dreieckrückstrahler Triangle reflector	Seitenmarkierungslicht + Reflektor Sidemarker light + reflector	

BEST. NR	PART NO	←	→	LED	24V	ZUSATZ	ANSCHLUSS	
						ADD ON	CONNECTOR	
25-7430-721	1/10	●		LED	24V		7 pol. AMP 7 pin AMP ♂ ♂	4 x 2 pol. Superseal 4 x 2 pin Superseal
25-7400-501	1/10	●		LED	24V		7 pol. ASS2.1 7 pin ASS2.1 ♂ ♂	
25-7400-511	1/10	●		LED	24V		7 pol. ASS2.1 7 pin ASS2.1 ♂ ♂	4 x 2 pol. ASS2 4 x 2 pin ASS2
25-7400-701	1/10	●		LED	24V		7 pol. ASS2.1 7 pin ASS2.1 ♂ ♂	
25-7400-711	1/10	●		LED	24V		7 pol. ASS2.1 7 pin ASS2.1 ♂ ♂	4 x 2 pol. ASS2 4 x 2 pin ASS2
25-7400-721	1/10	●		LED	24V		7 pol. ASS2.1 7 pin ASS2.1 ♂ ♂	
25-7400-741	1/10	●		LED	24V		7 pol. ASS2.1 7 pin ASS2.1 ♂ ♂	
25-7401-531	1/10	●		LED	24V		7 pol. ASS2.1 7 pin ASS2.1 ♂ ♂	
25-7401-601	1/10	●		LED	24V		7 pol. ASS2.1 7 pin ASS2.1 ♂ ♂	4 x 2 pol. ASS2 4 x 2 pin ASS2
25-7430-711	1/10	●		LED	24V		7 pol. AMP 7 pin AMP ♂ ♂	4 x 2 pol. Superseal 4 x 2 pin Superseal
25-7401-611	1/10	●		LED	24V		7 pol. ASS2.1 7 pin ASS2.1 ♂ ♂	4 x 2 pol. ASS2 4 x 2 pin ASS2
25-7402-001	1/10	●		LED	24V		7 pol. ASS2.1 7 pin ASS2.1 ♂ ♂	4 x 2 pol. ASS2 4 x 2 pin ASS2
25-7400-761	1/10	●		LED	24V		7 pol. ASS2.1 7 pin ASS2.1 ♂ ♂	4 x 2 pol. ASS2 4 x 2 pin ASS2



EUROPOINT III links mit Umrissarm
left with end outline marker

ADR Zone 2 IP56K

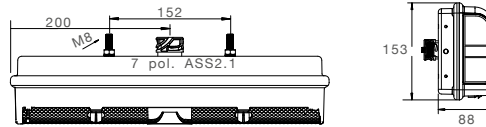
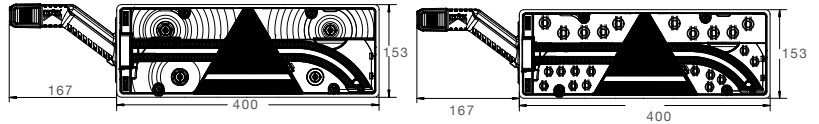

Blinklicht Direction indicator	Rücklicht Tail light	Bremslicht Stop light	Nebelschlusslicht Fog light
Rückfahrt Reverse light	Dreieckrückstrahler Triangle reflector	Seitenmarkierungslicht + Reflektor Sidemarker light + reflector	

BEST. NR	Part No	Box	←	→	LED	24V	LED	ZUSATZ	ANSCHLUSS
PART NO								ADD ON	CONNECTOR
25-7020-501	1/6	●			LED	24V	LED		7 pol. ASS2.1 7 pin ASS2.1
25-7020-511	1/6	●			LED	24V	LED		7 pol. ASS2.1 7 pin ASS2.1
25-7020-541	1/6	●			LED	24V	LED		7 pol. ASS2.1 7 pin ASS2.1
25-7020-701	1/6	●			LED	24V	LED		7 pol. ASS2.1 7 pin ASS2.1
25-7020-711	1/6	●			LED	24V	LED		7 pol. ASS2.1 7 pin ASS2.1
25-7020-721	1/6	●			LED	24V	LED		7 pol. ASS2.1 7 pin ASS2.1
25-7020-731	1/6	●			LED	24V	LED		7 pol. ASS2.1 7 pin ASS2.1
25-7021-511	1/6	●			LED	24V	LED		7 pol. ASS2.1 7 pin ASS2.1
25-7002-101	1/6	●			LED	24V	LED		7 pol. ASS2.1 7 pin ASS2.1
25-7020-741	1/6	●			LED	24V	LED		7 pol. ASS2.1 7 pin ASS2.1
25-7020-751	1/6	●			LED	24V	LED		7 pol. ASS2.1 7 pin ASS2.1
25-7021-521	1/6	●			LED	24V	LED		7 pol. ASS2.1 7 pin ASS2.1



EUROPOINT III rechts mit Umrissarm
right with end outline marker

ADR Zone 2 IP 56K

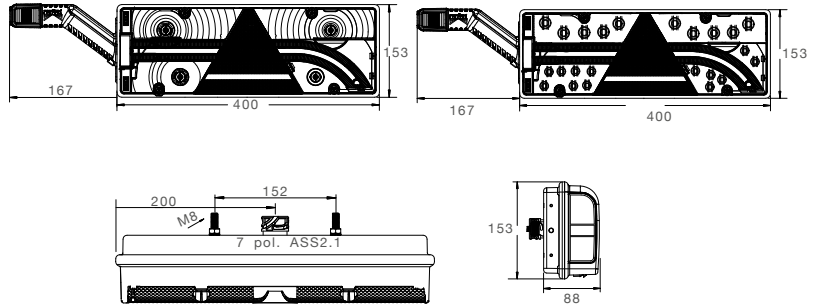

Blinklicht Direction indicator	Rücklicht Tail light	Bremslicht Stop light	Nebelschlusslicht Fog light
Rückfahrlicht Reverse light	Dreieckrückstrahler Triangle reflector	Seitenmarkierungslicht + Reflektor Sidemarker light + reflector	

BEST. NR	PART NO	←	→	LED	24V	LED	ZUSATZ	ANSCHLUSS
							ADD ON	CONNECTOR
25-7420-501	1/6		●	LED	24V	LED		7 pol. ASS2.1 7 pin ASS2.1 ♂
25-7420-511	1/6		●	LED	24V	LED		7 pol. ASS2.1 7 pin ASS2.1 ♂ 4 x 2 pol. ASS2 4 x 2 pin ASS2
25-7420-541	1/6		●	LED	24V	LED		7 pol. ASS2.1 7 pin ASS2.1 ♂ 4 x 2 pol. ASS2 4 x 2 pin ASS2
25-7420-551	1/6		●	LED	24V	LED		7 pol. ASS2.1 7 pin ASS2.1 ♂ 4 x 2 pol. ASS2 4 x 2 pin ASS2
25-7420-701	1/6		●	LED	24V	LED		7 pol. ASS2.1 7 pin ASS2.1 ♂
25-7420-711	1/6		●	LED	24V	LED		7 pol. ASS2.1 7 pin ASS2.1 ♂ 4 x 2 pol. ASS2 4 x 2 pin ASS2
25-7420-721	1/6		●	LED	24V	LED		7 pol. ASS2.1 7 pin ASS2.1 ♂
25-7420-751	1/6		●	LED	24V	LED		7 pol. ASS2.1 7 pin ASS2.1 ♂ 4 x 2 pol. ASS2 4 x 2 pin ASS2
25-7420-761	1/6		●	LED	24V	LED		7 pol. ASS2.1 7 pin ASS2.1 ♂
25-7421-521	1/6		●	LED	24V	LED		7 pol. ASS2.1 7 pin ASS2.1 ♂ 4 x 2 pol. ASS2 4 x 2 pin ASS2
25-7402-101	1/6		●	LED	24V	LED		7 pol. ASS2.1 7 pin ASS2.1 ♂ 4 x 2 pol. ASS2 4 x 2 pin ASS2
25-7420-741	1/6		●	LED	24V	LED		7 pol. ASS2.1 7 pin ASS2.1 ♂ 4 x 2 pol. ASS2 4 x 2 pin ASS2
25-7420-771	1/6		●	LED	24V	LED		7 pol. ASS2.1 7 pin ASS2.1 ♂ 4 x 2 pol. ASS2 4 x 2 pin ASS2
25-7421-531	1/6		●	LED	24V	LED		7 pol. ASS2.1 7 pin ASS2.1 ♂ 4 x 2 pol. ASS2 4 x 2 pin ASS2



EUROPOINT III Truck Version



IP 56K

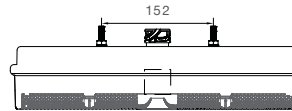
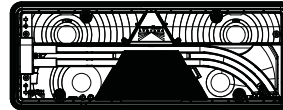

Blinklicht Direction indicator	Rücklicht Tail light	Bremslicht Stop light	Nebelschlusslicht Fog light
Rückfahrlicht Reverse light	Seitenmarkierungslicht + Reflektor Sidemarker light + reflector		

BEST. NR		←	→				ZUSATZ	ANSCHLUSS
PART NO							ADD ON	CONNECTOR
25-7000-541	1/10	●			24V			7 pol AMP 7 pin AMP ♂ ♂ ♂
25-7000-751	1/10	●			24V			7 pol AMP 7 pin AMP ♂ ♂ ♂
25-7400-541	1/10		●		24V			7 pol AMP 7 pin AMP ♂ ♂ ♂
25-7400-751	1/10		●		24V			7 pol AMP 7 pin AMP ♂ ♂ ♂



EUROPOINT III

ZUBEHÖR / ACCESSORIES

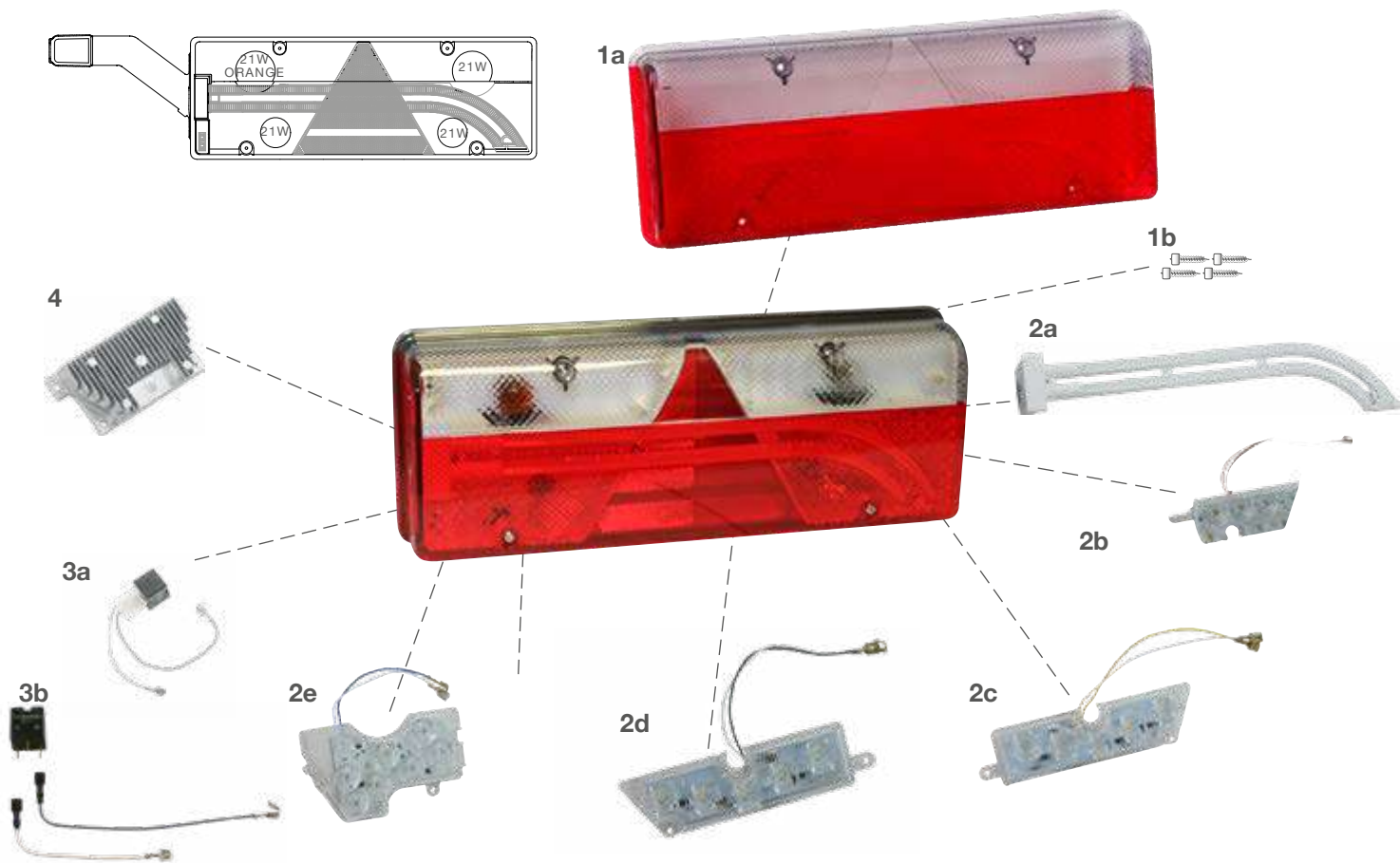

1 (a) Lichtscheibe | lens

- links
- left..... 18-8570-001
- rechts
- right 18-8570-101
- links mit KZL
- left with no. plate lamp 18-8570-011
- rechts mit KZL
- right with no. plate lamp 18-8570-111

(b) Schrauben für Lichtscheibe | Screws for lens

- 14-1430-554

2 LED Einsätze | LED inserts

- (a) Rücklicht links („Light Guide“) 12V / 24V
- tail left („Light Guide“) 12V / 24V
- 12-1570-001
- Rücklicht rechts („Light Guide“) 12V / 24V
- tail right („Light Guide“) 12V / 24V
- 12-1570-101
- (b) Bremslicht links 12V / 24V
- stop left 12V / 24V
- 12-1570-204

- Bremslicht rechts 12V / 24V
- stop light right 12V / 24V
- 12-1574-204

- (c) Blinklicht links 24V
- direction indicator left 24V
- 12-1570-224

- Blinklicht rechts 24V
- direction indicator right 24V
- 12-1574-224

- (d) Rückfahrlicht links 24V
- reverse left 24V 12-1570-234
- Rückfahrlicht rechts 24V
- reverse right 24V 12-1574-234

- (e) Nebelschlusslicht links 24V
- fog left 24V 12-1570-214
- Nebelschlusslicht rechts 24V
- fog right 24V 12-1574-214

3 Relais

- (a) Rückfahrwarner 24V
- reverse alarm 24V
- 12-3922-004
- (b) SMCG Steuerung für Seitenmarkierungsleuchten
- SMCG side marker control gear
- 12-3970-584



EUROPOINT III

ZUBEHÖR / ACCESSORIES



4 LED Vorschaltgerät | LED control gear
 LCG 25-7008-024
 siehe Seite 188
 see at page 188

5 Schutzhaube | protection cap
 (a) klein
 small 15-5270-004
 (b) groß
 big 15-5276-004
 (c) groß
 big 25-7537-154

6 Umrissarm LED | outline marker LED
 links 12V / 24V
 left 12V / 24V 31-3103-024
 rechts 12V / 24V
 right 12V / 24V 31-3102-024

7 Sicherung | fuse
 3 A 12-6830-094

8 ASS1 & ASS2 Verbinder | ASS1 & ASS2 connector
 (a) 2 pol. weiblich
 2 pin female 13-5626-401
 (b) 7 pol. weiblich
 7 pin female 13-5626-631
 (c) Verschlusskappe
 closed connection 15-5623-304

9 Superseal Verbinder | Superseal connector
 2 pol. weiblich
 2 pin female 15-7002-044

10 AMP Verbinder | AMP connector
 7 pol. weiblich
 7 pin female 15-7002-024

Glühlampe | bulb
 24V 21W orange 16-6321-617
 24V 21W 16-6321-037