

**REGPOINT KENNZEICHENLEUCHE**

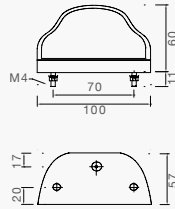

**DC-FLACHKABEL, INKL. LEUCHTMITTEL**



**BESCHREIBUNG**

0,8 m  
1,5 m  
0,8 m, rote Lichtscheibe

**BEST. NR.**

36-3209-017  
36-3209-027  
36-3209-147

**ERSATZTEILE UND ZUBEHÖR**



**BESCHREIBUNG**

Leuchte lose mit Tülle  
Transparente rote Lichtscheibe  
DC-Verbinder  
Soffitte 5W / 12V

**BEST. NR.**

26-3200-007  
18-8630-104  
15-5976-017  
16-6605-017

**REGPOINT LED KENNZEICHENLEUCHE LED**



**DC-FLACHKABEL**

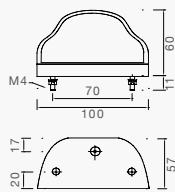

**BESCHREIBUNG**

0,8 m

**BEST. NR.**

36-3509-007

**ERSATZTEILE UND ZUBEHÖR**

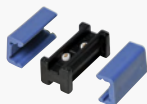

**BESCHREIBUNG**

DC-Verbinder

**BEST. NR.**

15-5976-017

# 12V LEUCHTEN KENNZEICHENLEUCHTEN



## REGPOINT II LED KENNZEICHENLEUCHE LED

### DC-FLACHKABEL

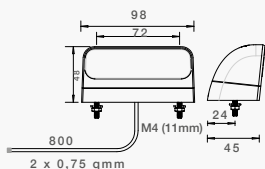

### BESCHREIBUNG

0,8 m  
1,5 m

**BEST. NR.**  
36-3809-007  
36-3809-017

### VERSION FÜR EINZELANBAU, DC-FLACHKABEL

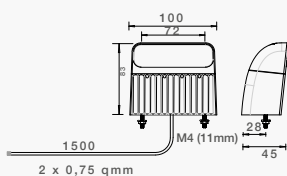

### BESCHREIBUNG

1,5 m

**BEST. NR.**  
36-3869-007

## REGPOINT SMALL KENNZEICHENLEUCHE

### DC-FLACHKABEL, INKL. LEUCHTMITTEL

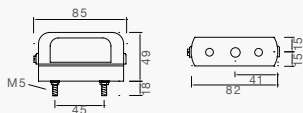

### BESCHREIBUNG

0,8 m  
1,5 m

**BEST. NR.**  
36-1209-017  
36-1209-027

### ERSATZTEILE UND ZUBEHÖR



### BESCHREIBUNG

Leuchte lose mit Tülle  
DC-Verbinder  
Soffitte 5W / 12V

**BEST. NR.**  
26-1200-007  
15-5976-017  
16-6605-017

## REGPOINT SMALL LED KENNZEICHENLEUCHE

### DC-FLACHKABEL

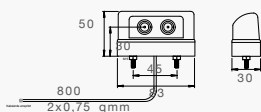

### BESCHREIBUNG

0,8 m

**BEST. NR.**  
36-1209-707

### ERSATZTEILE UND ZUBEHÖR

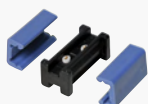

### BESCHREIBUNG

DC-Verbinder

**BEST. NR.**  
15-5976-017

## REGPOINT LED BUILT-IN KENNZEICHENLEUCHE LED



### REGPOINT LED BUILT-IN 82mm

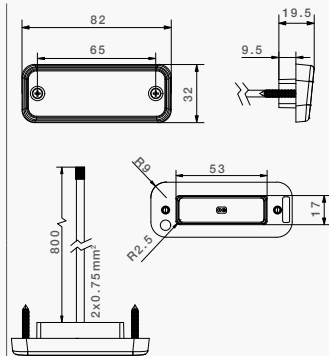

#### BESCHREIBUNG

0,8 m DC Flachkabel  
1,5 m mit 6,3 Flachsteckzunge

#### BEST. NR.

36-3904-407  
36-3904-607

### REGPOINT LED BUILT-IN 91mm

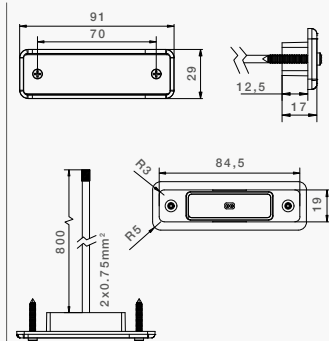

#### BESCHREIBUNG

0,5 m DC Flachkabel  
0,2 m mit 6,3 Flachsteckzunge  
0,5m DC Flachkabel + Gehäuse

#### BEST. NR.

36-3904-007  
36-3904-207  
36-3904-017

## KENNZEICHENHALTER FLEX LED



### DC-FLACHKABEL

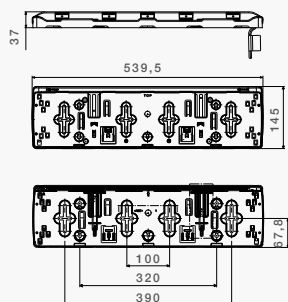
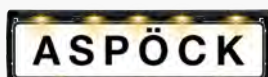

#### BESCHREIBUNG

0,8 m Kabel

#### BEST. NR.

36-3704-287

# 12V LEUCHTEN KENNZEICHENHALTER



## KENNZEICHENHALTER INKL. 2 X KENNZEICHENLEUCHE LED

### DC-FLACHKABEL

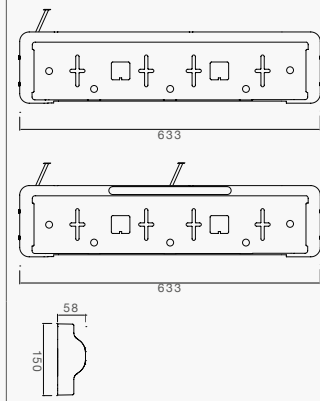

### BESCHREIBUNG

0,8 m

0,8 m + 3. Bremsleuchte 1,0 m

### BEST. NR.

36-3769-007

36-3769-017

### ERSATZTEILE UND ZUBEHÖR

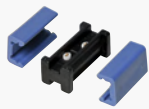

### BESCHREIBUNG

DC-Verbinder

### BEST. NR.

15-5976-017

## KENNZEICHENUNTERLAGEN

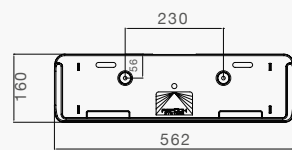

### BESCHREIBUNG

KZ Unterlage  
520 x 120 x 28 mm

### BEST. NR.

15-5392-017

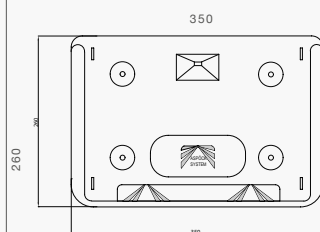

KZ Unterlage „Version UK“  
345 x 256 x 28 mm

15-5398-507

### ERSATZTEILE UND ZUBEHÖR



### BESCHREIBUNG

Halter für Regpoint-Leuchte

### BEST. NR.

15-5398-067