



aspoeck.com

MULTILED II

KOMPAKTE 5-FUNKTIONS-
LEUCHTE

COMPACT 5 FUNCTION LAMP



A.PIERINGER GmbH

www.ap.works

2141 Ameis, Obere Hauptstraße 68

Telefon: +43 / 2425 / 278 00

E-Mail: vk@ap.co.at



PRODUCT INFO

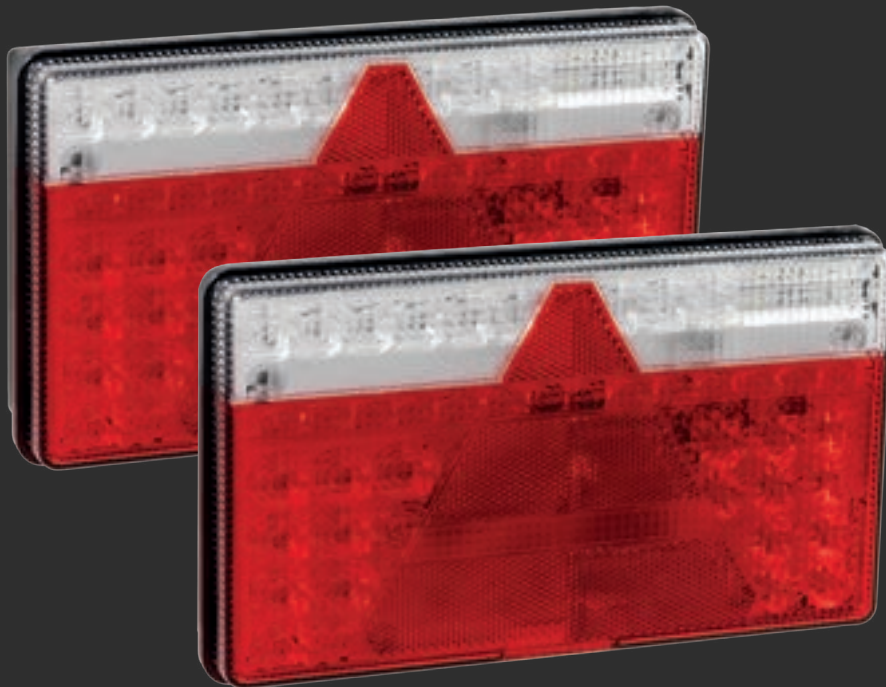



MULTILED II

KOMPAKTE 5-FUNKTIONSLEUCHE
COMPACT 5 FUNCTION LAMP

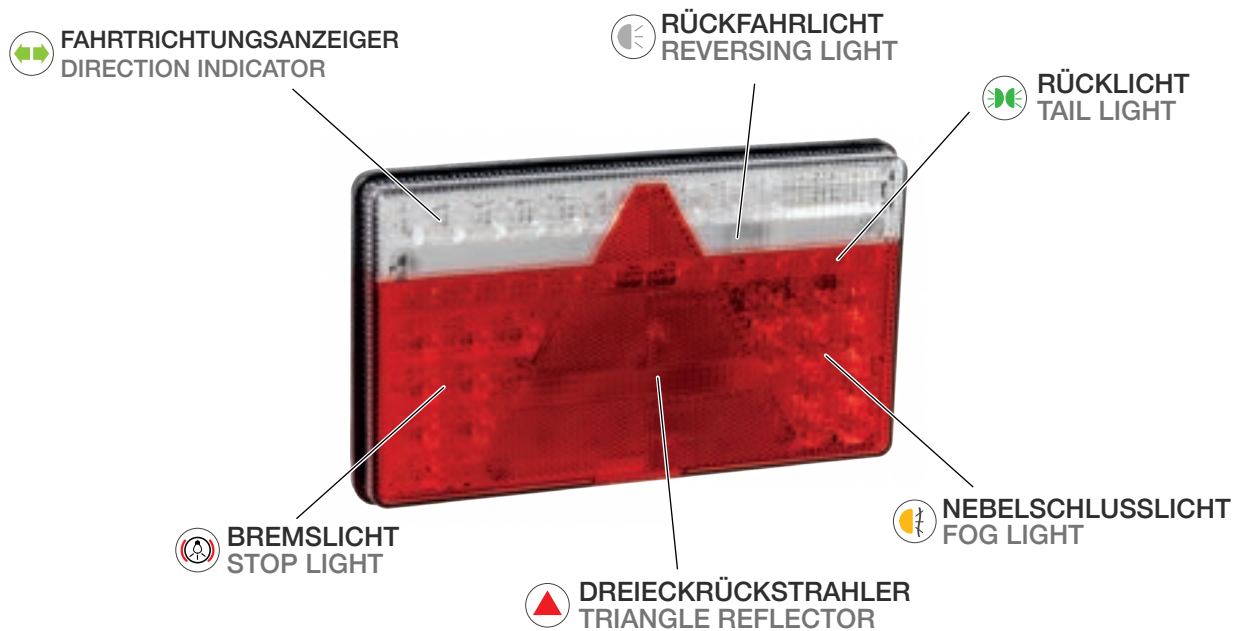

FAHRRICHTUNGSANZEIGER DIRECTION INDICATOR	RÜCKLICHT TAIL LIGHT	BREMSLICHT STOP LIGHT	NEBELSCHLUSSLICHT FOG LIGHT
RÜCKFAHRLICHT REVERSE LIGHT	DREIECKRÜCKSTRAHLER TRIANGLE REFLECTOR	KENNZEICHENBELEUCHTUNG NUMBER PLATE LAMP	

ADR Zone 2 IP6K9K

FEATURES

VOLL LED
FULL LED

IN ZWEI VERSCHIEDENEN BAUTIEFEN ERHÄLTlich (FLACH UND HOCH)
AVAILABLE IN TWO DIFFERENT HOUSING TYPES (FLAT AND HIGH)

WAHLWEISE MIT KENNZEICHENBELEUCHTUNG
OPTIONALLY WITH NUMBER PLATE LIGHT

DUAL VOLTAGE

A.PiERiNGER GmbH
www.ap.works

2141 Ameis, Obere Hauptstraße 68
Telefon: +43 / 2425 / 278 00
E-Mail: vk@ap.co.at

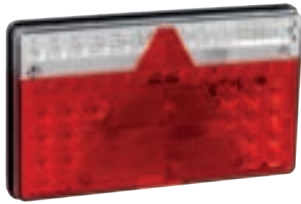

MULTILED II HOCH LINKS
MULTILED II DEEP LEFT



MULTILED II FLACH RECHTS
MULTILED II FLAT RIGHT

TECHNISCHE DATEN TECNICAL FACTS	
SPANNUNGSBEREICH: VOLTAGE RANGE:	
9-32 V	
ANSCHLUSS: CONNECTOR:	
0,5 m Kabel mit offenem Ende 0.5 m open ended cable	
MATERIAL: MATERIAL:	GEHÄUSE: HOUSING:
	ABS
	LICHTSCHEIBE: LENS:
	PMMA
TEMPERATURBEREICH: TEMPERATURE RANGE:	
- 40°C~ +60°C	
IP-KLASSE: IP-RATING:	
IP6K9K	
EMV-ABNAHME: EMC APPROVAL:	
JA YES	

MULTILED II HOCH LINKS MULTILED II DEEP LEFT

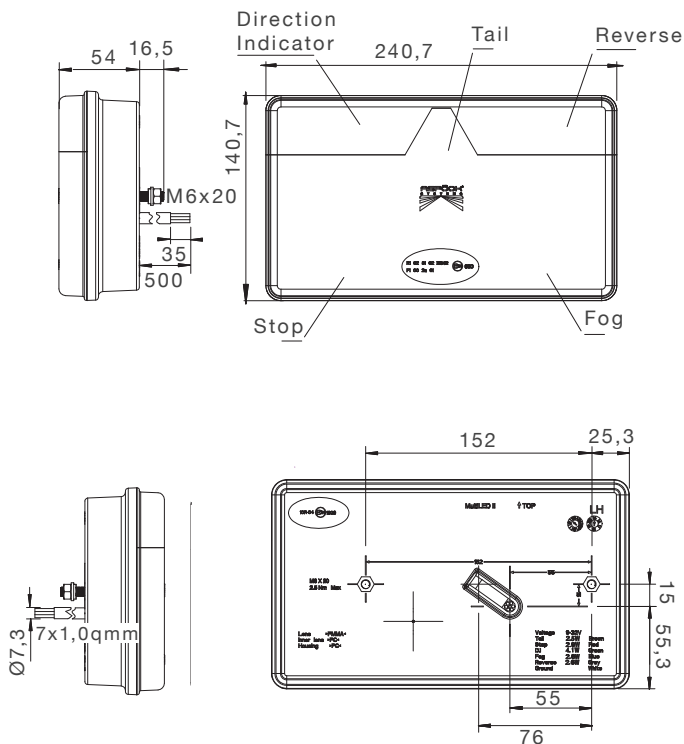

MULTILED II FLACH RECHTS MULTILED II FLAT RIGHT

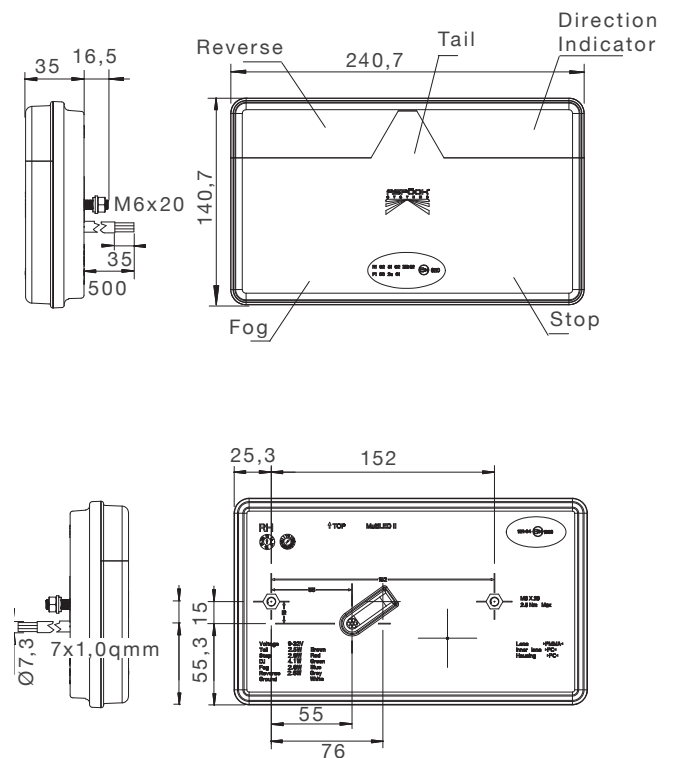

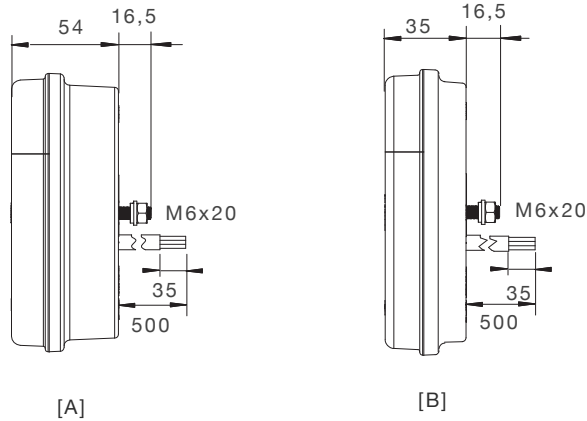

MULTILED II HOCH (A)
MULTILED II HIGH (A)

BEST. NR PART NO		BEST. NR AM PART NO AM	←	→			ZUSATZ ADD ON	ANSCHLUSS CONNECTOR		
35-0203-007	20	35-0203-001	●		LED	12V 24V		offenes Ende open end	0,50 m	
35-0204-007	20	35-0204-001		●	LED	12V 24V		offenes Ende open end	0,50 m	
35-0203-017	10	35-0203-011	●		LED	12V 24V		5 pol. Bajonett 5 pin Bayonet	0,50 m	
35-0204-017	10	35-0204-011		●	LED	12V 24V		5 pol. Bajonett 5 pin Bayonet	0,50 m	
35-0203-027	10	35-0203-021	●		LED	12V 24V		8 pol. Bajonett 8 pin Bayonet	0,50 m	
35-0204-027	10	35-0204-021		●	LED	12V 24V		8 pol. Bajonett 8 pin Bayonet	0,50 m	
35-0203-037	10	35-0203-031	●		LED	12V 24V		7 pol. ASS2 7 pin ASS2	0,50 m	
35-0204-037	10	35-0204-031		●	LED	12V 24V		7 pol. ASS2 7 pin ASS2	0,50 m	
35-0203-057	20	35-0203-051	●		LED	12V 24V		offenes Ende open end	0,50 m	
35-0204-057	20	35-0204-051		●	LED	12V 24V		offenes Ende open end	0,50 m	
35-0203-107	20	35-0203-101	●		LED	12V 24V		offenes Ende open end	0,50 m	
35-0204-107	20	35-0204-101		●	LED	12V 24V		offenes Ende open end	0,50 m	
35-0203-067	10	35-0203-061	●		LED	12V 24V		5 pol. Bajonett 5 pin Bayonet	0,50 m	
35-0204-067	10	35-0204-061		●	LED	12V 24V		5 pol. Bajonett 5 pin Bayonet	0,50 m	
35-0203-117	10	35-0203-111	●		LED	12V 24V		5 pol. Bajonett 5 pin Bayonet	0,50 m	
35-0204-077	10	35-0204-071		●	LED	12V 24V		8 pol. Bajonett 8 pin Bayonet	0,50 m	
35-0203-077	10	35-0203-071	●		LED	12V 24V		8 pol. Bajonett 8 pin Bayonet	0,50 m	
35-0204-087	10	35-0204-081		●	LED	12V 24V		7 pol. ASS2 7 pin ASS2	0,50 m	
35-0203-087	10	35-0203-081	●		LED	12V 24V		7 pol. ASS2 7 pin ASS2	0,50 m	
35-0204-137	10	35-0204-131		●	LED	12V 24V		7 pol. ASS2 7 pin ASS2	0,50 m	
35-0203-137	10	35-0203-131	●		LED	12V 24V		7 pol. ASS2 7 pin ASS2	0,50 m	

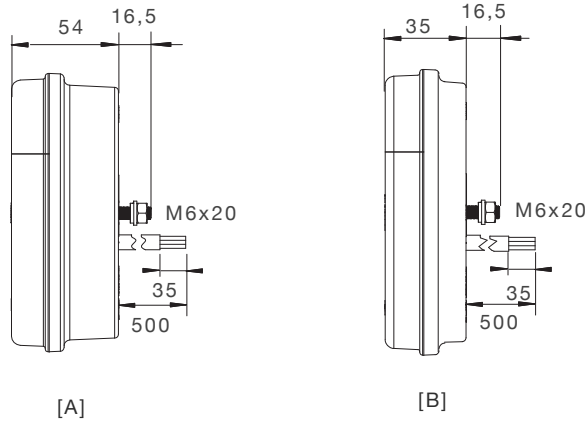

MULTILED II FLACH (B) MULTILED II FLAT (B)

BEST. NR PART NO		BEST. NR AM PART NO AM	←	→			ZUSATZ ADD ON	ANSCHLUSS CONNECTOR	
35-0201-007	20	35-0201-001	●		LED	12V 24V		offenes Ende open end	0,50 m
35-0202-007	20	35-0202-001		●	LED	12V 24V		offenes Ende open end	0,50 m
35-0201-017	10	35-0201-011	●		LED	12V 24V		5 pol. Bajonett 5 pin Bayonet	0,50 m
35-0202-017	10	35-0202-011		●	LED	12V 24V		5 pol. Bajonett 5 pin Bayonet	0,50 m
35-0201-027	10	35-0201-021	●		LED	12V 24V		8 pol. Bajonett 8 pin Bayonet	0,50 m
35-0202-027	10	35-0202-021		●	LED	12V 24V		8 pol. Bajonett 8 pin Bayonet	0,50 m
35-0201-037	10	35-0201-031	●		LED	12V 24V		7 pol. ASS2 7 pin ASS2	0,50 m
35-0202-037	10	35-0202-031		●	LED	12V 24V		7 pol. ASS2 7 pin ASS2	0,50 m
35-0201-047	10	35-0201-041	●		LED	12V 24V		7 pol. AMP 7 pin AMP	0,50 m
35-0202-047	10	35-0202-041		●	LED	12V 24V		7 pol. AMP 7 pin AMP	0,50 m

A.PiERiNGER GmbH

www.ap.works





















































2141 Ameis, Obere Hauptstraße 68

Telefon: +43 / 2425 / 278 00

E-Mail: vk@ap.co.at



PIKTOGRAMM ÜBERSICHT PICTOGRAM OVERVIEW

	Verpackungseinheit packaging unit		Seitenmarkierungslicht + Reflektor sidemarker + reflector
	x Stück pro Karton x pieces per box		Positionslicht hinten rear position light
	links left		positionslicht vorne front position light
	rechts right		rot, weiß, orange red, white, amber
	Leuchtmittel light source		rot, weiß red, white
	Volt		rot red
	Umrißarm end outline marker		weiß white
	Glühbirne bulb		Umrißleuchte end outline marker
	LED		Rückstrahler rot reflector red
	Fahrrichtungsanzeiger direction indicator		Rückstrahler gelb reflector amber
	Fahrrichtungsanzeiger rechts direction indicator right		Rückstrahler weiß reflector white
	Fahrrichtungsanzeiger links direction indicator left		Arbeitscheinwerfer working lamp
	dynamischer Fahrrichtungsanzeiger dynamic direction indicator		Kennzeichenbeleuchtung unten number plate lamp bottom
	dynamischer Fahrrichtungsanzeiger rechts dynamic direction indicator right		Kennzeichenbeleuchtung seitlich number plate lamp side
	dynamischer Fahrrichtungsanzeiger links dynamic direction indicator left		Rückfahralarm reverse alarm
	SMCG (Steuerung blinkender Seitenmarkierungsleuchten) SMCG (side marker control gear)		männlich male
	mit integriertem Blink-LCG with integrated direction indicator LCG		weiblich female
	mit integriertem LCG2 with integrated LCG2		Flood
	Rücklicht tail light		Spot
	Bremslicht stop light		horizontal Anbau horizontal mounting
	Nebelschlusslicht fog light		vertikal Anbau vertical mounting
	Rückfahrlicht reverse light		360° Anbau möglich 360° mounting possible
	Dreieckrückstrahler triangle reflector		... Lumen
	ohne Dreieckrückstrahler without triangle reflector		... Watt
	Positionslicht position light		ADR Zone 2
	Seitenmarkierungslicht sidemarker light		IP xx Schutzklasse IP xx rating
	Reflektor (Seitenmarkierungslicht) reflector (sidemarker light)		

product information_Multiled_II_V2 | 2024-07

Misprints, technical changes and illustrations are subject to change.

© Aspöck Systems GmbH

Non-compliance with the information given (e.g. temperature) results in the exclusion of warranty/liability. For details, see the mounting instructions/TSD www.aspoeck.com.